

SILFRA

Silfra Tek integral filler, waste & overflow

Finish: Chrome & Brushed Nickel

D6 (Chrome)

D6BN (Brushed Nickel)

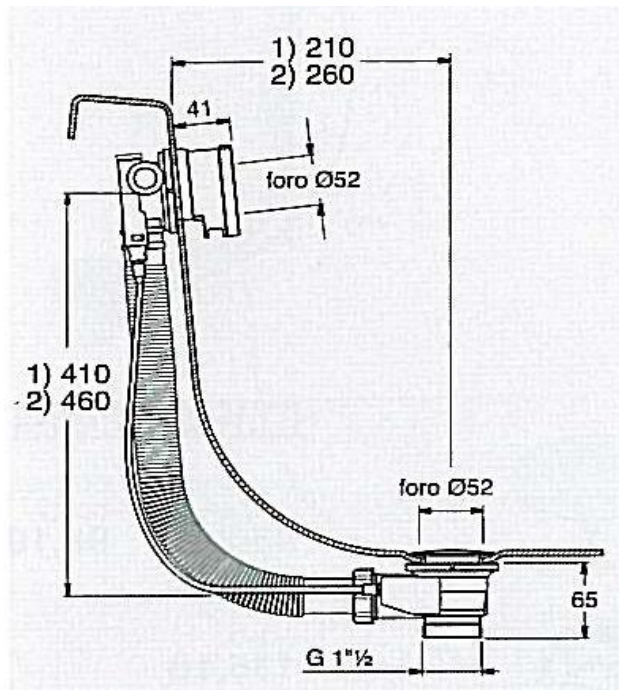

Made in Italy

1 Year Warranty

For Equal Pressure only

Max. Operating Pressure: 500Kpa.

Min. Operating Pressure: 50Kpa.

Pipework must be flushed before installation

Please install as per manufacturers instructions in the box

Available finishes:

Brushed Nickel



Due to our policy of continuous product development, the design and specification shown are subject to change without notice.

Please confirm all particulars with your sales consultant prior to purchase.